

ICOM

INSTRUCTION MANUAL

COMMUNICATIONS RECEIVER
IC-R1500

Icom Inc.



FOREWORD

Thank you for purchasing this Icom product. The IC-R1500 COMMUNICATIONS RECEIVER is designed and built with Icom's state of the art technology and craftsmanship. With proper care, this product should provide you with years of trouble-free operation.

We want to take a couple of moments of your time to thank you for making your IC-R1500 your radio of choice, and hope you agree with Icom's philosophy of "technology first." Many hours of research and development went into the design of your IC-R1500.

◆ FEATURES

- *Wide frequency coverage with all mode receive*
- *Both Remote controller operation and PC control application are available*
- *ANF and NR functions are available (Only when the optional DSP unit is installed.)*
- *IF shift function*

IMPORTANT

READ ALL INSTRUCTIONS carefully and completely before using the receiver.

SAVE THIS INSTRUCTION MANUAL— This instruction manual contains important operating instructions for the IC-R1500.

EXPLICIT DEFINITIONS

WORD	DEFINITION
⚠ WARNING!	Personal injury, fire hazard or electric shock may occur.
CAUTION	Equipment damage may occur.
NOTE	Recommended for optimum use. No risk of personal injury, fire or electric shock.

Icom, Icom Inc. and the ICOM logo are registered trademarks of Icom Incorporated (Japan) in the United States, the United Kingdom, Germany, France, Spain, Russia and/or other countries.

PRECAUTIONS

⚠ WARNING! NEVER connect the receiver via the OPC-254L to an AC outlet. This may pose a fire hazard or result in an electric shock.

⚠ WARNING! NEVER operate the receiver while driving a vehicle. Safe driving requires your full attention— anything less may result in an accident.

NEVER connect the receiver to a power source of more than 14 V DC. This will damage the receiver.

NEVER connect the receiver to a power source using reverse polarity. This will damage the receiver.

NEVER cut the DC power cable between the DC plug and fuse holder. If an incorrect connection is made after cutting, the receiver may be damaged.

NEVER expose the receiver to rain, snow or any liquids. The receiver may be damaged.

NEVER operate or touch the receiver with wet hands. This may result in an electric shock or damage the receiver.

NEVER place the receiver where normal operation of the vehicle may be hindered or where it could cause bodily injury.

NEVER let objects impede the operation of the cooling fan on the rear panel.

AVOID using or placing the receiver in direct sunlight or in areas with temperatures below -10°C ($+14^{\circ}\text{F}$) or above $+60^{\circ}\text{C}$ ($+140^{\circ}\text{F}$).

BE CAREFUL! The receiver will become hot when operating it continuously for long periods.

AVOID setting the receiver in a place without adequate ventilation. Heat dissipation may be affected, and the receiver may be damaged.

AVOID the use of chemical agents such as benzine or alcohol when cleaning, as they can damage the receiver's surfaces.

For U.S.A. only

CAUTION: Changes or modifications to this device, not expressly approved by Icom Inc., could void your authority to operate this device under FCC regulations.

SUPPLIED ACCESSORIES

Supplied accessories is described in the IC-PCR1500's Instruction manual.

SPECIFICATIONS

Specifications is described in the IC-PCR1500's Instruction manual.

OPTIONS

UT-106* DSP UNIT

Provides AF DSP functions such as noise reduction and auto notch.

CP-12L CIGARETTE LIGHTER CABLES

For operation and charging via a 12 V cigarette lighter socket.

OPC-254L DC POWER CABLES

For operation and charging via an external power supply.

SP-10 EXTERNAL SPEAKER

For all-round mobile operation. Cable length: 1.5 m; 4.9 ft

OPC-1156 SEPARATION CABLE

For extended separate installation. 3.5 m; 11.5 ft

*: UT-106 installation is described in the IC-PCR1500's Instruction manual.

TABLE OF CONTENTS

FOREWORD	i
IMPORTANT	i
EXPLICIT DEFINITIONS	i
PRECAUTIONS	ii
SUPPLIED ACCESSORIES	iii
SPECIFICATIONS	iii
OPTIONS	iii
TABLE OF CONTENTS	iii

1 CONNECTION	1-2
■ Rear panel connection	1
■ Antenna installation	2
2 PANEL DESCRIPTION	3-7
■ Front panel—controller	3
■ Function display—controller	5
■ Rear panel—main unit	7
3 SETTING A FREQUENCY	8-10
■ Turning power ON/OFF	8
■ Mode selection	8
■ Tuning step selection	9
■ Setting a frequency	9
■ Receive mode selection	10
4 BASIC OPERATION	11-15
■ Receiving	11
■ Monitor function	11
■ Lock function	11
■ Attenuator function	12
■ NB function	12
■ AGC function	12

■ AFC function	13
■ VSC function	13
■ IF filter selection	14
■ IF shift function	14
■ Duplex operation	15
5 MEMORY OPERATION	16–24
■ General description	16
■ Memory channel selection	16
■ Programming a memory channel	17
■ Programming channel names	18
■ Copying memory contents	19
■ Memory clearing	21
■ Memory bank setting	22
■ Memory bank selection	23
■ Transferring bank contents	23
6 SCAN OPERATION	25–29
■ Scan types	25
■ Scan start/stop	26
■ Scan edges programming	27
■ Skip scan	28
■ Scan resume condition	29
7 PRIORITY WATCH	30
■ Priority watch types	30
■ Priority watch operation	30
8 POCKET BEEP AND TONE SQUELCH	31–34
■ Pocket beep operation	31
■ Tone/DTCS squelch operation	33
■ Tone scan	34
9 SET MODE	35–41
■ General	35
■ Set mode items	35

10 OTHER FUNCTIONS	42–46
■ Weather channel operation	42
■ DSP operation	43
■ DATA cloning	44
■ Partial reset.....	45
■ All reset.....	45
■ Internal audio switch.....	46
11 TROUBLESHOOTING	47
12 DOC	48

1

CONNECTION

■ Rear panel connection

The double sided tape is set to the antenna holder. Remove the protective paper when the antenna is fixed to any place.

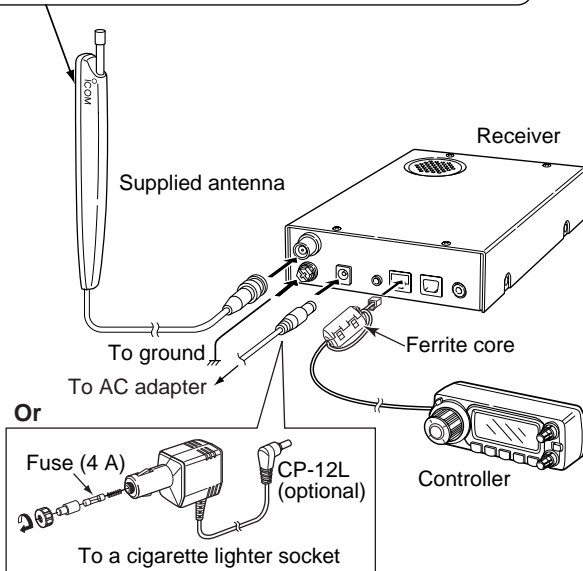

◇ DC power supply connection

Use a 12 V DC power supply with at least 4 A capacity. Make sure the ground terminal of the DC power supply is grounded.

• CONNECTING TO A DC POWER SUPPLY

Connects to a 12 V DC battery. Pay attention to polarities. **NEVER** connect to a 24 V battery. This could damage the receiver.

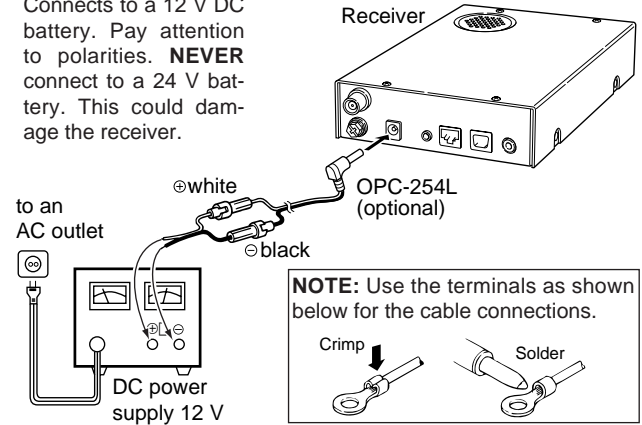

NOTE: Use the terminals as shown below for the cable connections.

⚠ CAUTION! NEVER remove the fuse-holders from the DC power cable.

◇ Fuse replacement

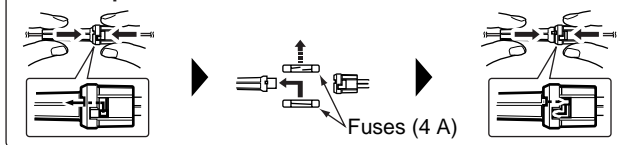

◆ OPC-1156 connection

- ① Connect the controller plug to the OPC-1156 joint.
- ② Detach the ferrite core from the controller cable, then attach it to the OPC-1156 as shown below.
 - Make sure to roll the cable to the ferrite core.
- ③ Connect the OPC-1156 plug to the [CONTROLLER] connector of the receiver.

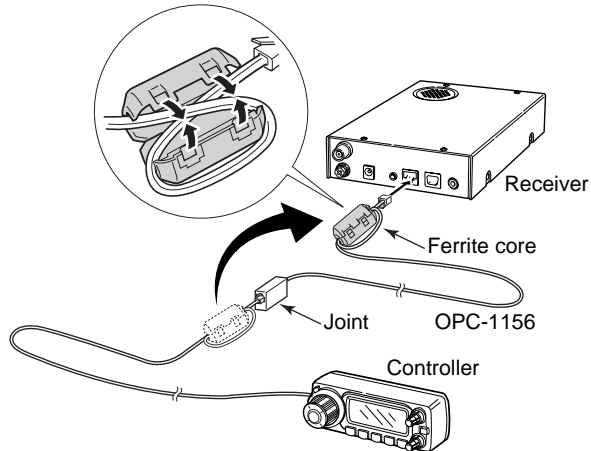

■ Antenna installation

◆ Antenna location

To obtain maximum performance from the receiver, select a high-quality antenna and mount it in a good location. A non-radial antenna should be used when using a magnetic mount.

■ Front panel—controller

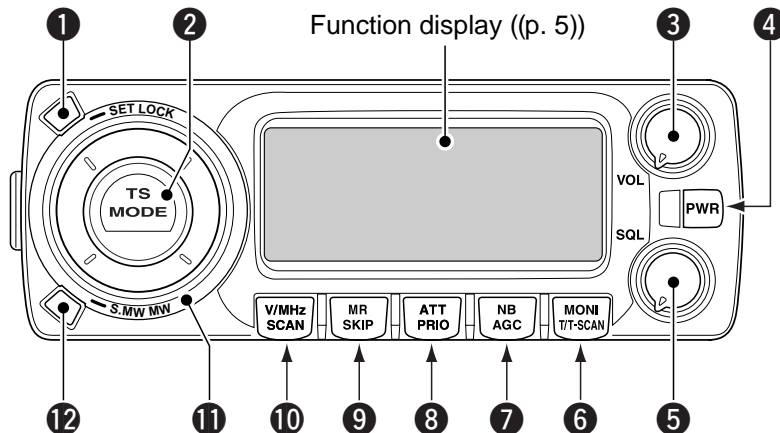

1 SET•LOCK SWITCH [SET•LOCK]

- Push to enter *set mode*. ((p. 35))
- Push and hold for 1 sec. to turn the lock function ON and OFF. ((p. 11))

2 TUNING STEP/MODE SWITCH [TS•MODE]

- Push to enter *tuning step selection mode*. ((p. 9))
 - Rotate [DIAL] to select the desired tuning step.
- Push and hold for 1 sec. to enter *receive mode selection mode*. ((p. 10))
 - Rotate [DIAL] to select the desired operating mode.

3 VOLUME CONTROL [VOL] ((p. 11))

Adjusts the audio level.

4 POWER SWITCH FOR CONTROLLER [PWR]

Push to turn the controller power ON when it's OFF.
 • Push and hold for 1 sec. to turn the controller power OFF when it's ON.

5 SQUELCH CONTROL [SQL]

Varies the squelch level. ((p. 11))

6 MONITOR•TONE•TONE SCAN SWITCH [MONI•T/T-SCAN]

- ➔ Push to turn the monitor function ON and OFF. ((p. 11))
- ➔ Push and hold for 1 sec. to enter *tone squelch selection mode*. ((pgs. 31, 33))
 - Tone squelch, pocket beep (CTCSS), tone squelch reverse action, DTCS squelch, pocket beep (DTCS), DTCS squelch reverse action or tone function OFF can be selected.
- ➔ Push and hold for 1 sec. during *tone squelch selection mode* to start the tone scan. ((p. 34))

7 NOISE BLANKER/AUTOMATIC GAIN CONTROL SWITCH [NB•AGC]

- ➔ Push to turn the NB (Noise Blanker) function ON and OFF. ((p. 12))
 - The noise blanker function cannot be used in FM/WFM modes.
- ➔ Push and hold for 1 sec. to select the AGC (Automatic Gain Control) function Slow and Fast. ((p. 12))
 - ▨ While in FM or WFM mode, the AGC function is fixed as Fast and AGC Slow cannot be selected.

8 ATTENUATOR/PRIORITY SWITCH [ATT•PRIO]

- ➔ Push to turn the ATT (Attenuator) function ON and OFF. ((p. 12))
- ➔ Starts priority watch when pushed and held for 1 sec. ((p. 30))

9 MEMORY/SKIP SWITCH [MR•SKIP]

- ➔ Push to select the memory channel, memory bank or weather channel* modes. ((pgs. 16, 23, 42))
 - *Weather channels are available for USA/CANADA versions only.

- ➔ Push and hold for 1 sec. to turn the channel skip setting ON and OFF for memory/frequency skip scan operation. ((p. 28))

10 VFO/MHz TUNING•SCAN SWITCH [V/MHz•SCAN]

- ➔ Selects and toggles *VFO mode* and band selection, 1 MHz or 10 MHz tuning when pushed. ((p. 9))
- ➔ Starts scan when pushed and held for 1 sec. ((p. 26))
 - Cancels a scan when pushed during scan.

11 TUNING DIAL [DIAL]

Selects the operating frequency ((p. 9)), memory channel ((p. 16)), the setting of the set mode item ((p. 35)) and the scanning direction ((p. 26)).

12 MEMORY WRITE SWITCH [S.MW•MW] ((pgs. 17, 18, 21))

- ➔ Selects a memory channel for programming when pushed.
- ➔ Programs the selected memory channel when pushed and held for 1 sec.

13 POWER SWITCH FOR RECEIVER [POWER]

Turns the receiver power ON and OFF.

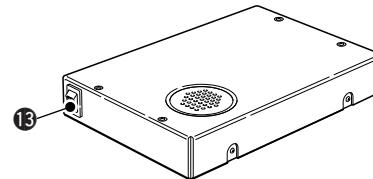

■ Function display—controller

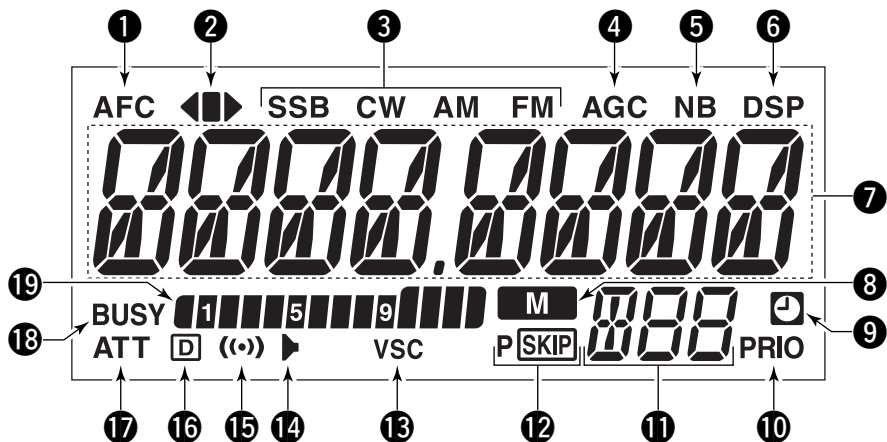

① AFC INDICATOR

Appears when the AFC function is in use. ((p. 13))

② FM CENTER INDICATORS

- ↳ “◀” or “▶” appears when the received signal is not tuned to its center frequency; or the squelch is closed.
- ↳ “■” appears when the received signal is tuned to its center frequency.

③ RECEIVE MODE INDICATORS

Shows the selected receive mode.

- SSB (LSB/USB), CW, AM and FM (FM/WFM) are available.

④ AGC INDICATOR ((p. 12))

Appears when the AGC fast is selected in SSB, CW or AM mode.

⑤ NB INDICATOR ((p. 12))

Appears when the NB function is in use.

6 DSP INDICATOR ((p. 43))

Appears when the DSP digital filter function is in use.

- The DSP function requires an optional UT-106 installation.

7 FREQUENCY READOUT

Shows the operating frequency, channel names, set mode contents, etc.

- Frequency decimal point blinks while scanning. ((p. 26))

8 MEMORY INDICATOR ((p. 16))

Appears when *memory mode* is selected.

9 AUTO POWER-OFF INDICATOR ((p. 36))

Appears while the auto power OFF function is in use.

10 PRIORITY INDICATOR ((p. 30))

Appears while the priority watch is activated; blinks while the watch is paused.

11 MEMORY CHANNEL NUMBER INDICATORS

- ➔ Shows the selected memory channel number. ((p. 16))
- ➔ Shows the selected bank initial. ((p. 23))
- ➔ “L” appears when the lock function is activated. ((p. 11))

12 SKIP INDICATORS ((p. 28))

- ➔ “**SKIP**” appears when the displayed memory channel is specified as a skip channel.
- ➔ “**P SKIP**” appears when the displayed frequency is specified as a program skip frequency.

13 VSC INDICATOR ((p. 13))

Appears when the VSC function is in use.

14 TONE SQUELCH INDICATOR ((p. 33))

Appears when the tone squelch function is in use.

15 POCKET BEEP INDICATOR ((p. 32))

Appears with “▶” or “□” while the pocket beep function (with CTCSS or DTCS) is in use.

16 DTCS SQUELCH INDICATOR ((p. 33))

Appears while the DTCS squelch function is in use.

17 ATT INDICATOR ((p. 12))

Appears when the ATT function is in use.

18 BUSY INDICATOR

- ➔ Appears when a signal is being received or the squelch is open. ((p. 11))
- ➔ Blinks while the monitor function is in use. ((p. 11))

19 S-METER INDICATORS

Shows the relative signal strength while receiving signals. ((p. 11))

2 PANEL DESCRIPTION

■ Rear panel—main unit

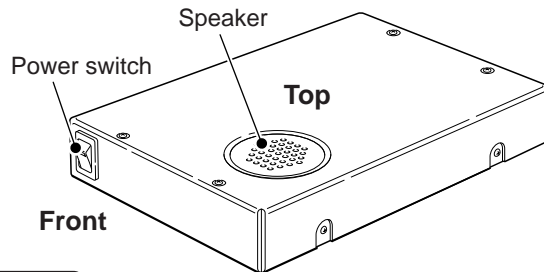
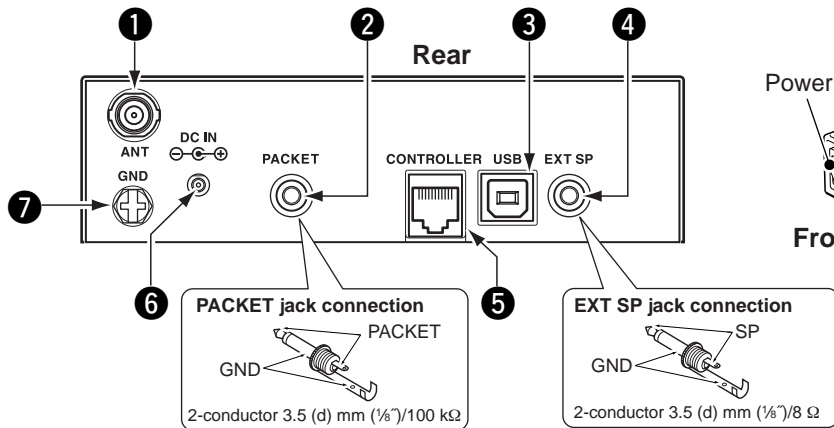

1 ANTENNA CONNECTOR [ANT]

Connects a 50 Ω antenna with a BNC connector and a 50 Ω coaxial cable.

2 DATA JACK [PACKET]

Connects a TNC (Terminal Node Controller), etc. for data communications. The receiver can receive 9600 bps packet communication (AFSK).

3 USB CONNECTOR [USB]

Connects to a PC via the supplied USB cable.

4 EXTERNAL SPEAKER JACK [EXT SP]

Connects an 8 Ω external speaker.

- Audio output power is more than 0.5 W.

5 CONTROLLER [CONTROLLER]

Connects to a controller via an extension cable.

6 POWER JACK [DC IN]

Accepts 12 V DC $\pm 15\%$ with the supplied DC power cable.

7 GROUND TERMINAL [GND]

Connect this terminal to a ground.

■ Turning power ON/OFF

- ➔ While receiver's power is OFF, push **[PWR]** to turn power ON.
 - While receiver power is ON, push and hold **[PWR]** for 1 sec. to turn power OFF.

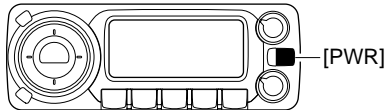

■ Mode selection

◇ VFO modes

VFO mode is used for the desired frequency setting within the frequency coverage.

- ➔ Push **[V/MHz•SCAN]** to select VFO mode.

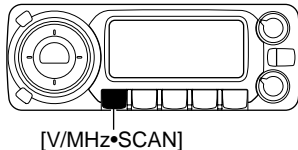

What is VFO?

VFO is an abbreviation of Variable Frequency Oscillator. Frequencies for receiving are generated and controlled by the VFO.

◇ Memory mode/Weather channels*

Memory mode is used for operation of memory channels which have programmed frequencies. Weather channels* are monitored each 5 sec. when the weather alert function is turned ON.

*Available for USA/CANADA versions only.

- ① Push **[MR•SKIP]** to select memory mode.
 - "M" indicator appears when memory mode is selected.
 - ➔ Or push **[MR•SKIP]** twice and rotate **[DIAL]** to select the Weather channel mode, then push **[MR•SKIP]** again.
 - Memory mode, memory banks or Weather channels can be selected in sequence.

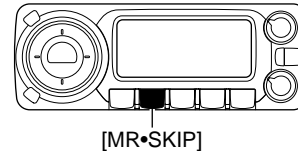

- If weather channel mode is already selected, and you want to select memory channel mode. Push **[MR•SKIP]** and rotate **[DIAL]** to select "bAnk --," then push **[MR•SKIP]** again.

- ② Rotate **[DIAL]** to select the desired channel.
 - Only programmed memory channels can be selected.
 - See ((p. 16)) for memory programming details.

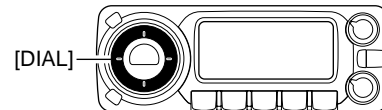

3 SETTING A FREQUENCY

■ Tuning step selection

When using the tuning dial to change the frequency, or when a scan function is activated, the frequency changes in increments determined by the set tuning step. This can be changed if desired.

The following tuning step are available.

- | | | |
|--------------------|--------------------|--------------------|
| • 0.01 kHz (10 Hz) | • 0.02 kHz (20 Hz) | • 0.05 kHz (50 Hz) |
| • 0.1 kHz (100 Hz) | • 0.5 kHz (500 Hz) | • 1 kHz |
| • 2.5 kHz | • 5 kHz | • 6.25 kHz |
| • 8.33 kHz | • 9 kHz | • 10 kHz |
| • 12.5 kHz | • 15 kHz | • 20 kHz |
| • 25 kHz | • 30 kHz | • 50 kHz |
| • 100 kHz | • 125 kHz | • 150 kHz |
| • 200 kHz | • 500 kHz | • 1000 kHz (1 MHz) |

- ① Push **[V/MHz•SCAN]** to select *VFO mode*, if necessary.
- ② Push **[TS•MODE]** to enter *tuning step select mode*.

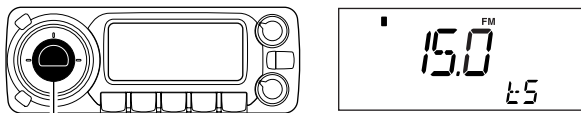

[TS•MODE]

- ③ Rotate **[DIAL]** to select the desired tuning step.

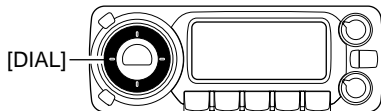

- ④ Push any switch to exit *tuning step select mode*.

■ Setting a frequency

- ① Rotate **[DIAL]** to set the frequency.
 - If *VFO mode* is not selected, push **[V/MHz•SCAN]** to select *VFO mode*.
 - The frequency changes in the selected tuning steps.

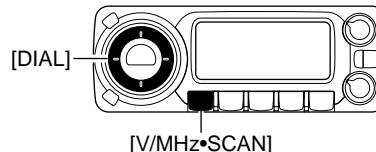

- ② To change the frequency band or in 1 MHz (10 MHz) steps, push **[V/MHz•SCAN]**, then rotate **[DIAL]**.
 - Pushing and holding **[V/MHz•SCAN]** for 1 sec. starts scan function. If scan starts, push **[V/MHz•SCAN]** again to cancel it.

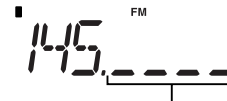

While the band selection mode is selected, the digits below 100 kHz disappear.



While 1 MHz tuning step is selected, the 1 MHz digit blinks.

While 10 MHz tuning step is selected, the 10 MHz digit blinks.

■ Receive mode selection

Receive modes are determined by the physical properties of the radio signals. The receiver has 6 receive modes: LSB, USB, CW, AM, WFM and FM modes. The mode selection is stored independently in each memory channels.

Typically, AM mode is used for the AM broadcast stations (0.495–1.620 MHz) and air band (118–135.995 MHz), and WFM is used for FM broadcast stations (76–107.9 MHz).

- ① Push and hold **[TS•MODE]** for 1 sec. to enter *receive mode select mode*.

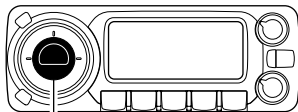

[TS•MODE]

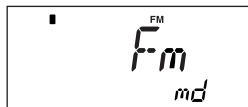

- ② Rotate **[DIAL]** to select the desired mode.

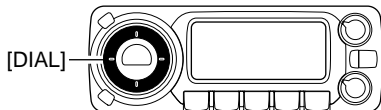

[DIAL]

- ③ Push any switch to exit *receive mode select mode*.

■ Receiving

- ① Push and hold **[PWR]** for 1 sec. to turn power ON.
- ② Set the audio level.
 - Push **[MONI•T/T-SCAN]** to open the squelch.
 - Rotate **[VOL]** to adjust the audio level.
 - Push **[MONI•T/T-SCAN]** to close the squelch.
- ③ Set the squelch level.
 - Rotate **[SQL]** fully counterclockwise in advance, then rotate **[SQL]** clockwise until the noise just disappears.
 - When interference is received, push **[ATT•PRIO]** momentarily to turn the attenuator function. ((p. 12))
- ④ Set the receive frequency and mode. ((pgs. 9, 10))
- ⑤ When receiving a signal on the set frequency, squelch opens and the receiver emits audio.
 - “BUSY” appears and the S-meter indicator shows the relative signal strength for the received signal.

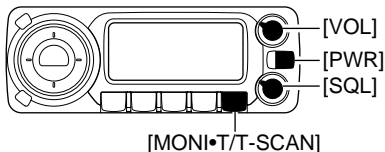

■ Monitor function

This function is used to listen to weak signals without disturbing the squelch setting or to open the squelch manually even when mute functions such as the tone squelch are in use.

- Push **[MONI•T/T-SCAN]** to open the squelch.
 - Push **[MONI•T/T-SCAN]** again to cancel the function.

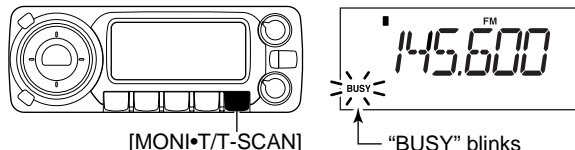

■ Lock function

To prevent accidental frequency changes and unnecessary function access, use the lock function.

- Push and hold **[SET•LOCK]** for 1 sec. to turn the lock function ON and OFF.
 - **[SET•LOCK]** (lock function only), **[MONI•T/T-SCAN]** (monitor function only), **[PWR]**, **[VOL]** and **[SQL]** can be used while the lock function is in use.

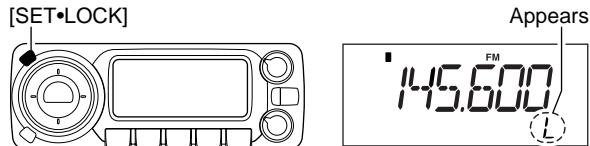

■ Attenuator function

The attenuator prevents a desired signal from distorting when very strong signals are near the desired frequency or when very strong electric fields, such as from a broadcasting station, are near your location. The attenuator gain is about 20 dB and this function can be activated on 1300 MHz or below.

- ➔ Push **[ATT•PRIO]** momentarily to toggle the attenuator function ON and OFF.
 - “ATT” appears when the attenuator function is in use.

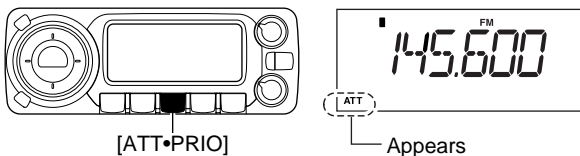

■ NB function

The NB (noise blanker) function removes pulse-type noise when SSB, CW or AM mode is selected.

- ➔ Push **[NB•AGC]** to toggle the NB function ON and OFF.
 - “NB” appears when the NB function is in use.

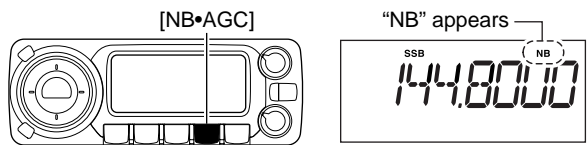

■ AGC function

The AGC (Automatic Gain Control) function controls receiver gain to produce a constant audio output level even when the received signal strength is varied by fading, etc. This AGC function is available for SSB, CW or AM mode.

- ➔ Push and hold **[NB•AGC]** for 1 sec. to toggle the AGC function Slow and Fast.
 - “AGC” appears when the AGC function (FAST) is selected in SSB, CW or AM mode.

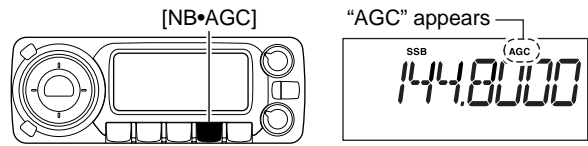

⚡ While in FM or WFM mode, the AGC function is fixed as Fast and AGC Slow cannot be selected.

4 BASIC OPERATION

■ AFC function

USING SET MODE

The AFC (Automatic Frequency Control) function tunes the displayed frequency automatically when an off-center frequency is received. It activates in FM mode and only when the selected IF filter is 6 kHz or 15 kHz.

- ① Select FM mode.
- ② Push **[SET•LOCK]** to enter *set mode*.
- ③ Push **[SET•LOCK]** or **[S.MW•MW]** several times until "AFC" appears.

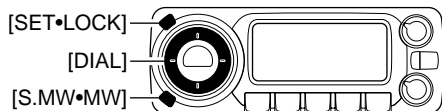

- ④ Rotate **[DIAL]** to toggle the AFC function ON and OFF.

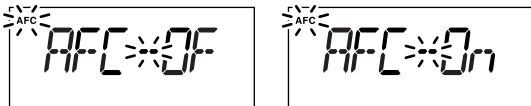

- ⑤ Push **[TS•MODE]** or any switch below the display to exit *set mode*.
 - "AFC" appears when the AFC function is in use.



■ VSC function

USING SET MODE

The VSC (Voice Squelch Control) function opens the squelch only when receiving a modulated signal. This function is very useful while scanning, the VSC pauses only when modulated signals are received. Scanning continues when unmodulated or beat signals are received.

- ① Push **[SET•LOCK]** to enter *set mode*.
- ② Push **[SET•LOCK]** or **[S.MW•MW]** several times until "VSC" appears.

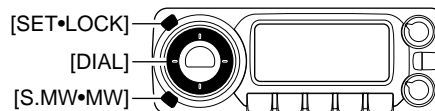

- ③ Rotate **[DIAL]** to toggle the VSC function ON and OFF.

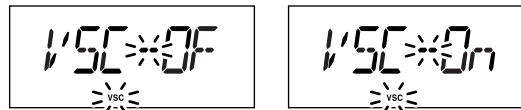

- ④ Push **[TS•MODE]** or any switch below the display to exit *set mode*.

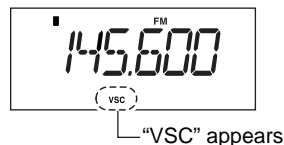

■ IF filter selection

USING SET MODE

The receiver has 2 to 4 passband width IF filters for each mode. Selectable passband width are from 3, 6, 15, 50 and 230 (depending on the selected mode).

● **Selectable passband width for each mode.**

- SSB mode : 3 (2.8 kHz) or 6 kHz
- CW mode : 3 (2.8 kHz) or 6 kHz
- AM mode : 3 (2.8 kHz), 6 kHz, 15 kHz or 50 kHz
- WFM mode: 50 kHz or 230 kHz
- FM mode : 6 kHz, 15 kHz or 50 kHz

- ① Push **[SET•LOCK]** to enter *set mode*.
- ② Push **[SET•LOCK]** or **[S.MW•MW]** several times until "FIL" appears.

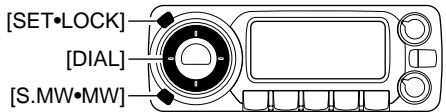

- ③ Rotate **[DIAL]** to select the desired IF passband width.

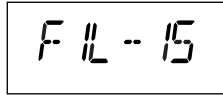

- ④ Push **[TS•MODE]** or any switch below the display to exit *set mode*.

■ IF shift function

USING SET MODE

The IF shift function electronically changes the passband frequency of the IF (Intermediate frequency) and cuts out higher or lower frequency components of the IF to reject interference. This function is available when the receive mode is selected SSB or CW mode, and shifts the IF frequency up to ± 25 steps in 1 step (50 Hz).

- ① Push **[SET•LOCK]** to enter *set mode*.
- ② Push **[SET•LOCK]** or **[S.MW•MW]** several times until "SFt" appears.

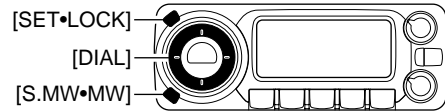

- ③ Rotate **[DIAL]** to set the shifting direction and frequency range.

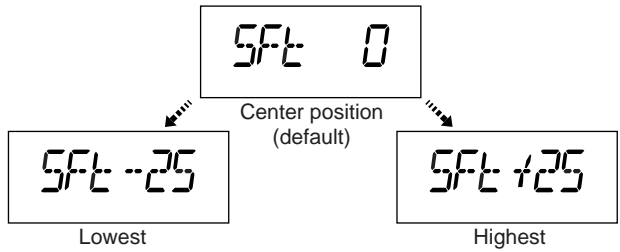

- ④ Push **[TS•MODE]** or any switch below the display to exit *set mode*.

4 BASIC OPERATION

■ Duplex operation

Duplex communication uses two different frequencies for transmitting and receiving. Generally, duplex is used in communication through a repeater, some utility communications, etc.

During duplex operation, the transmit station frequency is shifted from the receive station frequency by the offset frequency. Repeater information (offset frequency and shift direction) can be programmed into memory channels. ((p. 16))

◆ Setting

— USING SET MODE

- ① Push **[SET•LOCK]** to enter *set mode*.
- ② Push **[SET•LOCK]** or **[S.MW•MW]** several times until the duplex direction setting item “OFF dP,” “DUP– dP” or “DUP+ dP” appears.

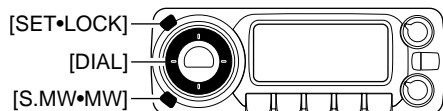

- ③ Rotate **[DIAL]** to select the duplex direction, “DUP– dP” or “DUP+ dP.”

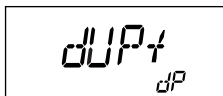
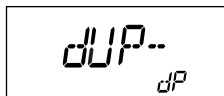

- ④ Push **[SET•LOCK]** once to select the offset frequency setting item.

- ⑤ Rotate **[DIAL]** to set the desired offset frequency within 0.000–1000.000 MHz range.
 - The tuning step, selected in *VFO mode*, is used for setting.
 - Push **[V/MHz•SCAN]** then rotate **[DIAL]** to change the frequency in 10 MHz steps, or push again then rotate **[DIAL]** to change the frequency in 1 MHz steps. (Each push toggles 1 MHz, 10 MHz or selected tuning steps.)

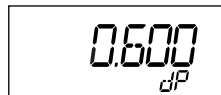

- ⑥ Push **[TS•MODE]** or any switch below the display to exit *set mode*.

◆ Operation

- ① Set the receive station frequency (repeater output frequency).
- ② Push **[MONI•T/T•SCAN]** to monitor the transmit station frequency (repeater input frequency) directly.

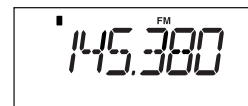
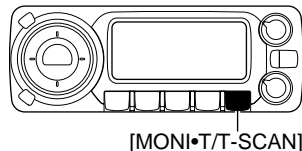

Frequency shifts the offset frequency

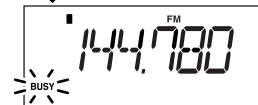

■ General description

The receiver has 1100 memory channels including 100 scan edge memory channels (50 pairs) for storage of often-used frequencies. And a total of 21 memory banks, A to H, J to R, T, U, W and Y are available for storing groups of frequencies, etc. Up to 100 channels can be assigned into a bank.

◇ Memory channel contents

The following information can be programmed into memory channels:

- Operating frequency ((p. 9))
- Receive mode ((p. 10))
- Duplex direction (DUP+ or DUP-) with an offset frequency ((p. 15))
- Tone squelch or DTCS squelch ON/OFF ((p. 33))
- Tone squelch frequency or DTCS code with polarity ((p. 38))
- Scan skip information ((p. 28))

■ Memory channel selection

- ① Push **[MR•SKIP]** to select *memory mode*.
 - “**M**” indicator appears.

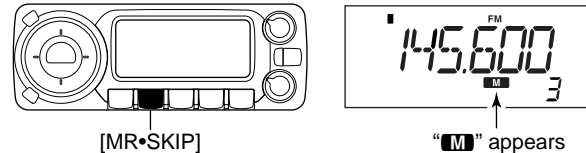

- ② Rotate **[DIAL]** to select the desired memory channel.
 - Programmed memory channels can only be selected.

If memory banks or weather channels* mode appears when pushed **[MR•SKIP]** at step ①, push **[MR•SKIP]** and rotate **[DIAL]** to select “bAnk --,” then push **[MR•SKIP]** again.

*Available for USA/CANADA versions only.

5 MEMORY OPERATION

■ Programming a memory channel

VFO settings, including the set mode contents such as sub-audible tone frequency or scan skip information, can be programmed into a memory channel.

- ① Push **[V/MHz•SCAN]** to select *VFO mode*.
- ② Set the desired frequency using **[DIAL]**.
 - ➔ Set other data (e.g. subaudible tone frequency, scan skip information, etc.) if required.
- ③ Push **[S.MW•MW]** to enter *select memory write mode*.
 - “**M**” indicator and the memory channel number blink.

- ④ Rotate **[DIAL]** to select the desired memory channel to be programmed.
 - Memory channels not yet programmed are blank.
- ⑤ Push and hold **[S.MW•MW]** for 1 sec. to program.
 - 3 beeps sound
 - Memory channel number automatically increases when continuing to push **[S.MW•MW]** after programming.

✓ CONVENIENT

Memory programming can be performed in versatile ways e.g. memory channel to the same (or different) memory channel, etc.

[EXAMPLE]: Programming 145.800 MHz into memory channel 20 (blank channel).

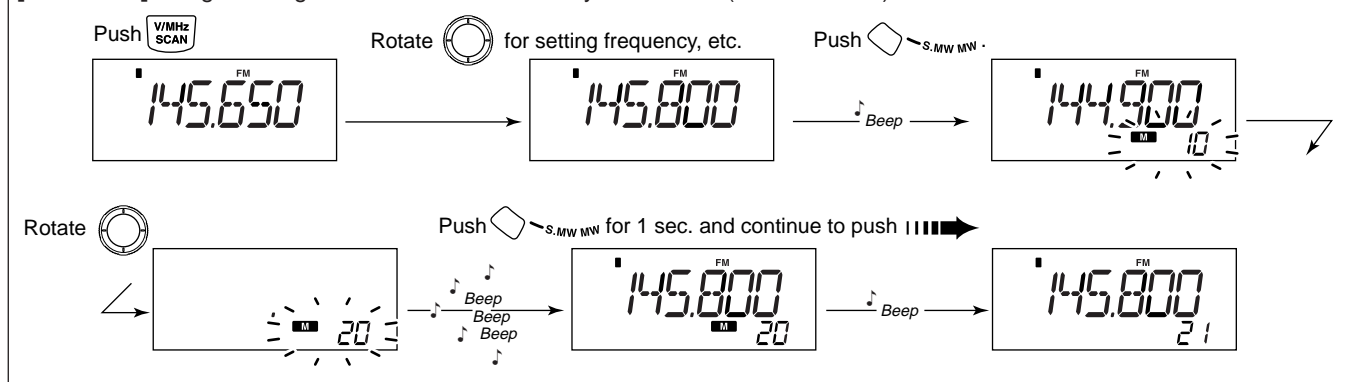

■ Programming channel names

Each memory channel can be programmed with an alphanumeric channel name for easy recognition and can be indicated independently by channel. Names can be a maximum of 6 characters— see the table below for available characters.

(space)	A(A)	b(B)	C(C)	d(D)	E(E)	F(F)	G(G)	H(H)
I(I)	J(J)	k(K)	L(L)	m(M)	n(N)	O(O)	P(P)	Q(Q)
R(R)	S(S)	t(T)	U(U)	v(V)	W(W)	X(X)	Y(Y)	Z(Z)
0(0)	1(1)	2(2)	3(3)	4(4)	5(5)	6(6)	7(7)	8(8)
9(9)	+(+)	-(-)	/(/)	=(=)				

- ① Select the desired memory channel to be programmed.
 - Push **[MR•SKIP]** to select *memory mode*, then rotate **[DIAL]** to select the desired memory channel.
- ② Push **[S.MW•MW]** to enter *select memory write mode*.
 - “**M**” indicator and the memory channel number blink.
- ③ Push **[TS•MODE]** twice to select the memory name programming condition, “m nAmE.”
 - Frequency readouts disappear and a cursor blinks.
- ④ Rotate **[DIAL]** to select the desired character.
 - The selected character blinks.
- ⑤ Push **[SET•LOCK]** to move the cursor to the right.
 - Repeat pushing **[SET•LOCK]** to return to the first digit.
- ⑥ Repeat steps ④ and ⑤ until the desired channel names are displayed.
- ⑦ Push and hold **[S.MW•MW]** for 1 sec. to program the name and exit *select memory write mode*.

[EXAMPLE]: Programming “CLUB” into memory channel 12.

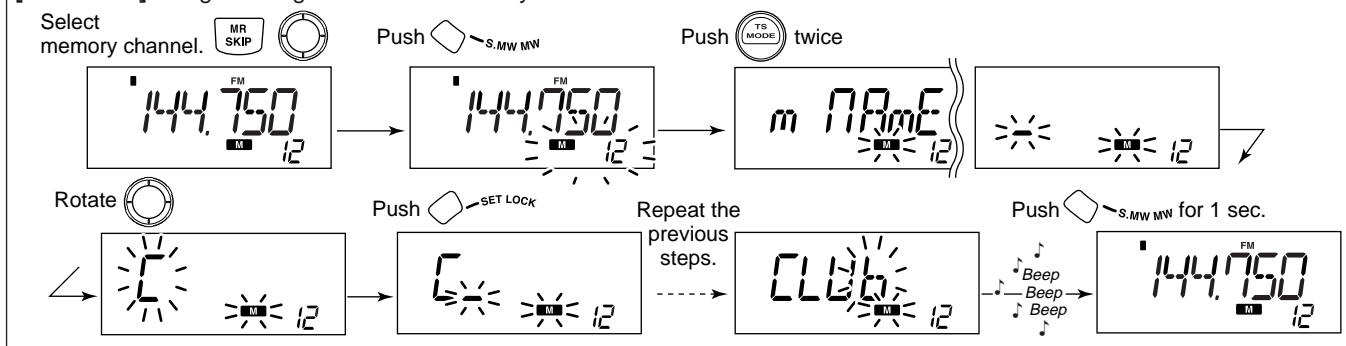

5 MEMORY OPERATION

◆ To indicate the channel name

MEMO SET MODE

The channel name indication can be set for independent memory channels.

- ① Select the desired memory channel.
 - ➔ Push **[MR•SKIP]** to select *memory mode*, then rotate **[DIAL]** to select the desired memory channel.
 - “**M**” and memory channel number appear.
- ② Push **[SET•LOCK]** to enter *set mode*.
- ③ Push **[SET•LOCK]** or **[S.MW•MW]** several times to select “Anm” item.
- ④ Rotate **[DIAL]** to turn the memory name indication ON.



- ⑤ Push **[TS•MODE]** to exit *set mode*.

NOTE: When no memory name is programmed, the stored frequency is displayed.

■ Copying memory contents

This function transfers a memory channel's contents to VFO (or another memory channel). This is useful when searching for signals around a memory channel frequency and for recalling the subaudible tone frequency etc.

◆ Memory ↔ VFO

- ① Select the desired memory channel to be copied.
 - ➔ Push **[MR•SKIP]** to select *memory mode*, then rotate **[DIAL]** to select the desired memory channel.
 - “**M**” and memory channel number appear.
- ② Push and hold **[S.MW•MW]** for 1 sec. to transfer the selected memory channel contents to *VFO mode*.
 - *VFO mode* is selected automatically.

◆ Memory ↔ memory

- ① Select the desired memory channel to be transferred.
 - ➔ Push **[MR•SKIP]** to select *memory mode*, then rotate **[DIAL]** to select the desired memory channel.
 - “**M**” and memory channel number appear.
- ② Push **[S.MW•MW]** momentarily.
 - “**M**” and memory channel number blink.
- ③ Rotate **[DIAL]** to select the target memory channel.
 - Scan edge channels, 0A/0B to 49A/49B can also be selected.
- ④ Push and hold **[S.MW•MW]** for 1 sec. to transfer the selected memory channel contents to the target memory.
 - The targeted memory and transferred contents are indicated.

[EXAMPLE]: Transferring memory channel 30 contents to VFO.

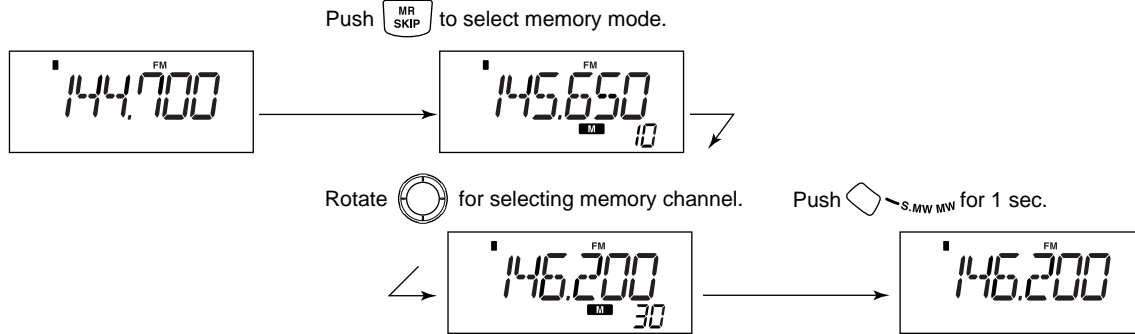

[EXAMPLE]: Transferring memory channel 22 contents to channel 23.

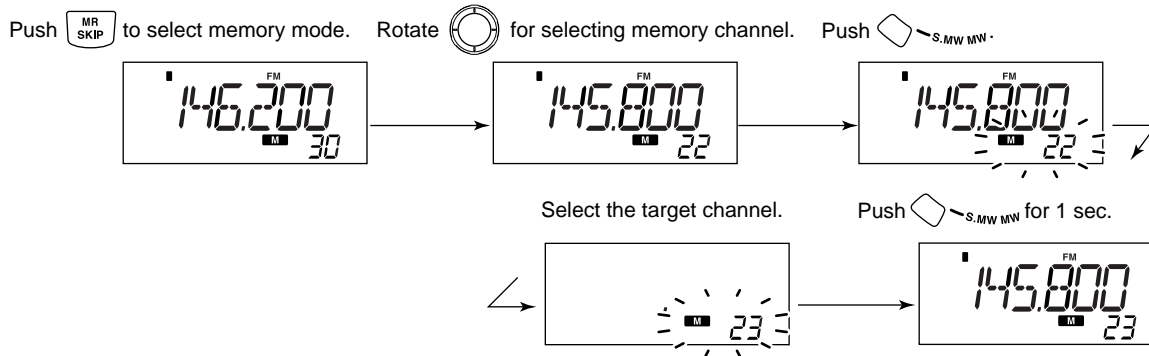

5 MEMORY OPERATION

■ Memory clearing

Contents of programmed memories can be cleared (blanked), if desired.

- ① Push **[V/MHz•SCAN]** to select *VFO mode*.
- ② Push **[S.MW•MW]** to enter *select memory write mode*.
 - “**M**” and the memory channel number blink.
- ③ Rotate **[DIAL]** to select the memory channel to be cleared.

- ④ Push **[TS•MODE]** three times to select “CLEAR,” then push and hold **[S.MW•MW]** for 1 sec.
 - 3 beeps sound.
 - The cleared channel changes to blank channel
 - “**M**” and the memory channel number blink continuously.
- ⑤ Push **[V/MHz•SCAN]** to return to *VFO mode*.

ⓘ **NOTE:** Be careful!— the contents of cleared memories **CANNOT** be recalled.

[EXAMPLE]: Clearing memory channel 20.

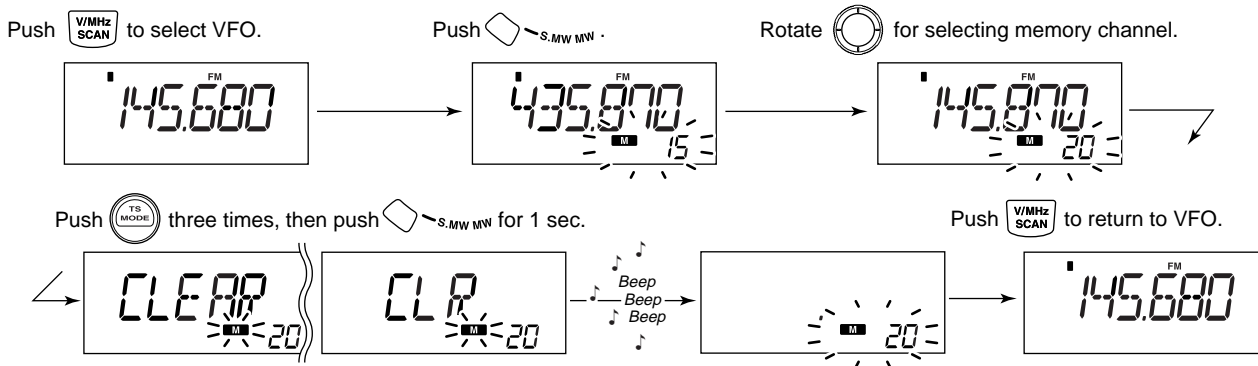

Memory bank setting

The IC-R1500 has a total of 21 banks (A to H, J to R, T, U, W, Y). Regular memory channels, 0 to 999, may assigned into the desired bank for easy memory management.

- ① Select the desired memory channel.
 - ➔ Push **[MR•SKIP]** to select *memory mode*, then rotate **[DIAL]** to select the desired memory channel.
 - “**M**” and memory channel number appear.
- ② Push **[S.MW•MW]** to enter *select memory write mode*.
 - “**M**” indicator and the memory channel number blink.
- ③ Push **[TS•MODE]** once to select “bAnk.”

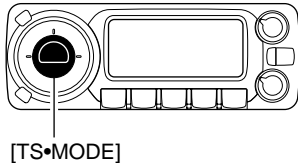

↓ After [TS•MODE] released

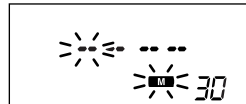

- ④ Rotate **[DIAL]** to select the desired bank and bank channel.
 - Push **[SET•LOCK]** to toggle the bank or bank channel selection.
 - Banks A to H, J to R, T, U, W and Y are available.
 - Vacant bank channel numbers are only be displayed.

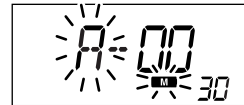

Bank selection



Bank channel selection

- ⑤ Push and hold **[S.MW•MW]** for 1 sec. to program the bank and exit *select memory write mode*.

5 MEMORY OPERATION

■ Memory bank selection

- ① Push **[MR•SKIP]** to select *memory mode*.
- ② Push **[MR•SKIP]** again to enter *memory type selection mode*.

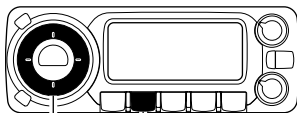

[DIAL] [MR•SKIP]



- ③ Rotate **[DIAL]** to select the desired bank (A to H, J to R, T, U, W or Y).
 - Only programmed banks are displayed.
- ④ Push any switch to set the bank indication.
 - Bank's indicator appears at top of the memory channel.
- ⑤ Rotate **[DIAL]** to select the contents in the bank.
- ⑥ To return to regular *memory mode*, repeat steps ②–④ and select "bAnk --" at step ③.

• Memory bank indication

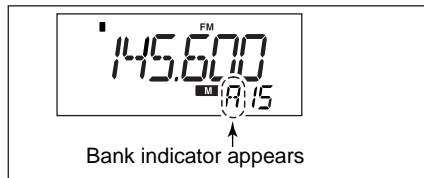

■ Transferring bank contents

USING SET MODE

The bank contents of programmed memory channels can be cleared or transferred to another bank.

/// INFORMATION: Even if the memory bank contents are cleared, the memory channel contents still remain programmed.

- ① Select the desired bank contents to be transferred or erased from the bank.
 - ➔ Push **[MR•SKIP]** to select *memory mode*.
 - ➔ Push **[MR•SKIP]** again then rotate **[DIAL]** to select the desired memory bank.

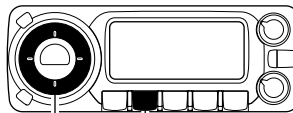

[DIAL] [MR•SKIP]



Bank's indicator appears

- ➔ Push any switch to select the bank then rotate **[DIAL]** to select the desired contents.
- ② Push **[S.MW•MW]** to enter *select memory write mode*.
 - "M" indicator and the memory channel number blink.

- ③ Push **[TS•MODE]** once to select “bAnk.”
- The bank’s indicator and bank channel are displayed.

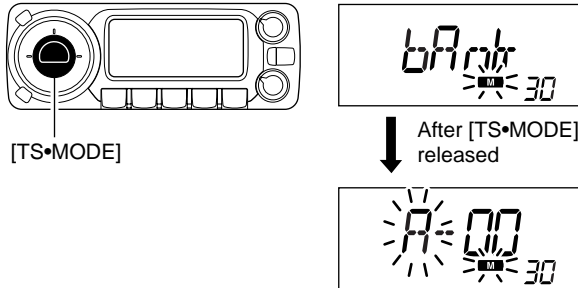

- ④ Rotate **[DIAL]** to select the desired bank indicator to transfer or erase.
- Push **[SET•LOCK]** to toggle the bank or bank channel selection.
 - Select “-- --” indication when erasing the contents from the bank.
 - Vacant bank channel numbers are only be displayed.

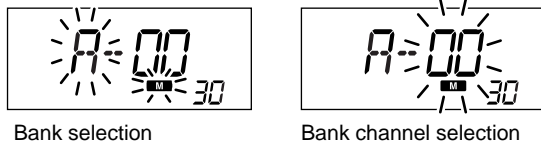

- ⑤ Push and hold **[S.MW•MW]** for 1 sec. to program the bank and exit select memory write mode.

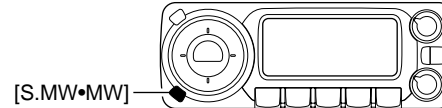

- ⑥ Repeat steps ① to ⑤ for transferring or erasing an another banks contents.

6

SCAN OPERATION

Scan types

Scanning searches for signals automatically and makes it easier to locate new stations for contact or listening purposes.

There are 5 scan types and 4 resume conditions to suit your operating needs.

FULL SCAN ((p. 26))

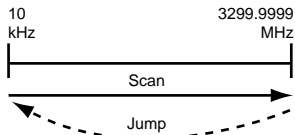

Repeatedly scans all frequencies over the entire band.

Some frequency ranges are not scanned according to the frequency coverage of the receiver's version.

PROGRAMMED SCAN ((p. 26))

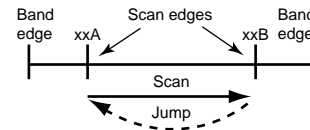

Repeatedly scans between two user-programmed frequencies. Used for checking for frequencies within a specified range such as repeater output frequencies, etc.

MEMORY (SKIP) SCAN ((p. 26))

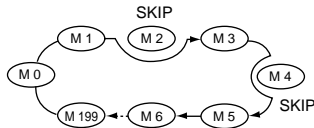

Repeatedly scans memory channels except those set as skip channel. Skip channels can be turned ON and OFF by pushing and holding **[MR•SKIP]** in *memory mode*.

ALL/SELECTED BANK SCAN ((p. 26))

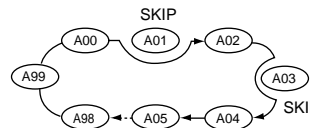

Repeatedly scans all bank channels or selected bank channels. The skip scan is also available.

FREQUENCY/MEMORY SKIP FUNCTION ((p. 28))

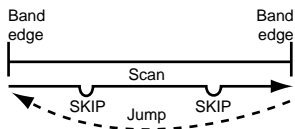

Skips unwanted frequencies or channels that inconveniently stop scanning. This function can be turned ON and OFF by pushing and holding **[MR•SKIP]** in *memory mode*.

■ Scan start/stop

◇ Preparation

Scan resume condition ((p. 29)); program the scan edges ((p. 27)); program two or more memory channels ((p. 17)); set skip settings ((p. 28)), if desired.

◇ Operation

- ① Push **[V/MHz•SCAN]** to select *VFO mode* for full/programmed scan; or push **[MR•SKIP]** to select *memory mode* for memory/bank scan.
 - Select the desired bank in *memory type selection mode* for bank scan.
- ② Set the squelch level to the point where noise is just muted.
- ③ Push and hold **[V/MHz•SCAN]** for 1 sec. to start the scan.
 - To change the scanning direction, rotate **[DIAL]**.
 - The memory channel readout blinks the scan type as below.

IMPORTANT!: To perform memory or bank scan, two or more memory/bank channels **MUST** be programmed, otherwise the scan will not start.

- ④ Push **[TS•MODE]** (or **[SET•LOCK]**) to switch full and programmed scan (P00 to P49), if VFO is selected in step ①.
- ⑤ To stop the scan, push **[V/MHz•SCAN]**.

/// **About the scanning steps:** The selected tuning step in each frequency band (in *VFO mode*) is used during scan.

/// The bank-link setting can be changed in *set mode*. See ((p. 40)) for details.

• During full scan

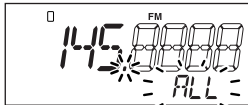

Push **[SET•LOCK]** to select full (ALL) or programmed scan (P00–P49) in sequence.

While pushing and holding **[V/MHz•SCAN]**, rotate **[DIAL]** also to select full (ALL) or programmed scan (P00–P49).

• During programmed scan

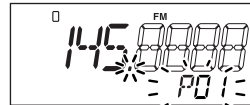

Indicates scan edge channels.

- P01 stands for 01A/01B
- P00 to P49 are available when they are programmed, and switches with **[SET•LOCK]**.

• During memory scan

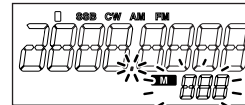

• During bank scan

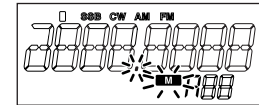

Indicates bank channel.

NOTE: When SSB, CW, AM, FM or WFM mode frequencies are programmed into memory channels disorderly, memory scan takes a lot of time (very slow). Because changing modes takes a time. In this case, assign the SSB, CW, AM, FM or WFM mode frequencies into the separate bank respectively. And using the bank scan is helpful.

6 SCAN OPERATION

■ Scan edges programming

Scan edges can be programmed in the same manner as memory channels. Scan edges are programmed into scan edges, 0A/0B to 49A/49B, in memory channels.

- ① Push **[V/MHz•SCAN]** to select *VFO mode*.
- ② Set the edge frequency of the desired frequency range:
 - ➔ Set the frequency using **[DIAL]**.
 - ➔ Set other data (e.g. tone squelch, etc.), if desired.
- ③ Push **[S.MW•MW]**.
 - “**M**” indicator and channel number blink.
- ④ Rotate **[DIAL]** to select one of scan edge channel, 0A to 49A.

- ⑤ Push and hold **[S.MW•MW]** for 1 sec. to program.
 - 3 beeps sound and *VFO mode* is automatically selected.
 - Scan edge 0B to 49B is automatically selected when continuing to push **[S.MW•MW]** after programming.
- ⑥ To program a frequency for the other pair of scan edges, 0B to 49B, repeat steps ① to ④.
 - If the same frequency is programmed into a pair of scan edges, programmed scan will not function.

[EXAMPLE]: Programming 144.000 MHz into scan edge 1A.

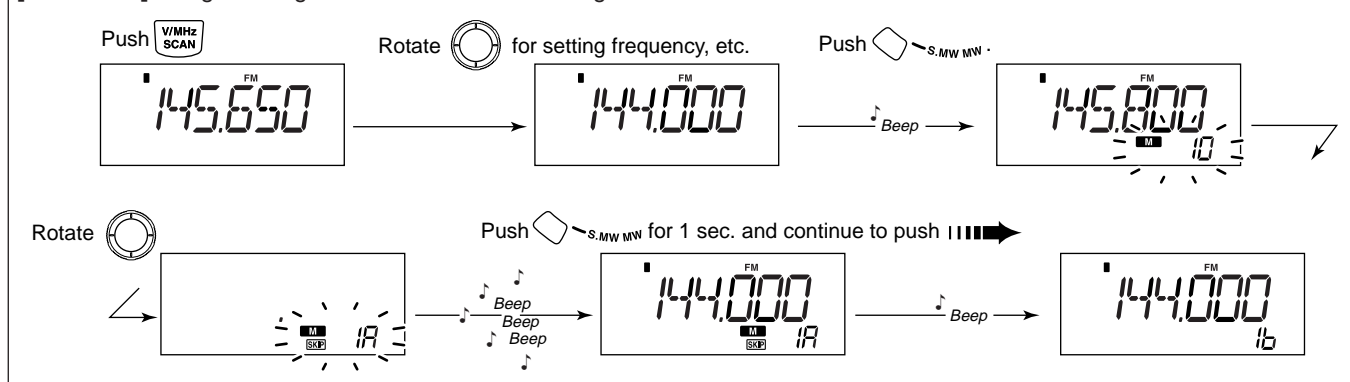

■ Skip scan

◇ Skip channel/frequency setting

You can set the selected memory channel as a skip channel which is skipped during memory skip scan. In addition, it can be set as a skip channel for both memory skip scan and frequency skip scan. These are useful to speed up the scan interval.

① Select a memory channel.

➔ Push **[MR•SKIP]** to select *memory mode*, then rotate **[DIAL]** to select the desired memory channel to be a skip channel.

• “**MM**” and memory channel number appear.

② Push and hold **[MR•SKIP]** for 1 sec. several times to set the skip condition.

- (no indication) : The channel is scanned during scan.
- **[SKIP]** : The channel is skipped during scan.
- **P[SKIP]** : The channel is skipped during scan and the programmed frequency is skipped during VFO scan, such as programmed scan.

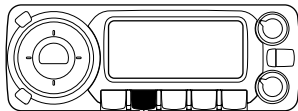

[MR•SKIP]



The display shows that memory channel 16 is set as a skip channel.

◇ Skip scan setting

USING SET MODE

- ① Push **[SET•LOCK]** to enter *set mode*.
- ② Push **[SET•LOCK]** or **[S.MW•MW]** several times until “PSC” appears.

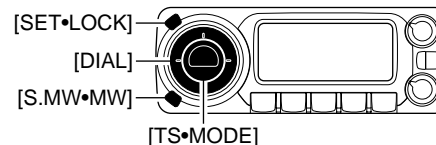

- ③ Rotate **[DIAL]** to toggle the skip scan function ON and OFF.

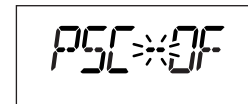
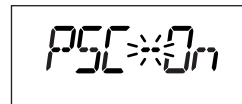

- ④ Push **[TS•MODE]** or any switch below the display to exit *set mode*.
- ⑤ Then start the scan to activate the skip scan (memory skip scan or frequency skip scan).

6 SCAN OPERATION

■ Scan resume condition USING SET MODE

The scan resume condition can be selected as timer or pause scan. The selected resume condition is also used for priority watch. ((p. 30))

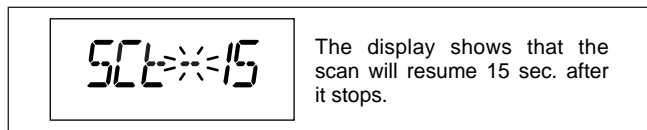

① Push **[SET•LOCK]** to enter *set mode*.

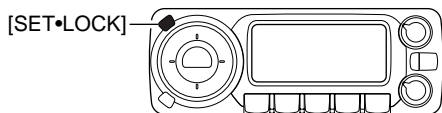

② Push **[SET•LOCK]** or **[S.MW•MW]** several times until “SCt” or “SCP” appears.

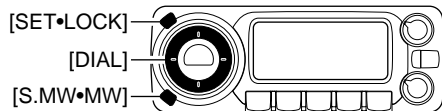

③ Rotate **[DIAL]** to set the desired timer:

- “SCP-2” : Scan pauses until the signal disappears and then resumes 2 sec. later.
- “SCt-15” : Scan pauses 15 sec. while receiving a signal.
- “SCt-10” : Scan pauses 10 sec. while receiving a signal.
- “SCt-5” : Scan pauses 5 sec. while receiving a signal.

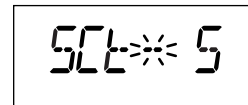
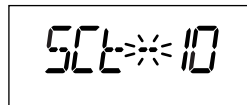
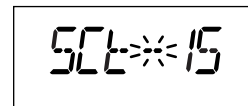
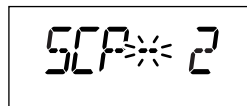

④ Push **[TS•MODE]** to exit *set mode*.

■ Priority watch types

Priority watch checks for signals on the frequency every 5 sec. while operating on a VFO frequency or scanning. The receiver has 3 priority watch types to suit your needs.

The watch resumes according to the selected scan resume condition. See ((p. 29)) for details.

/// **NOTE:** If the pocket beep function is activated, the receiver automatically selects the tone squelch function when priority watch starts.

MEMORY CHANNEL WATCH

While operating on a VFO frequency, priority watch checks for a signal on the selected memory channel every 5 sec.

- A memory channel with skip information can be watched.

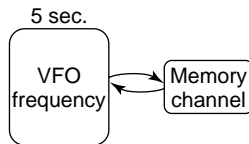

MEMORY SCAN WATCH

While operating on a VFO frequency, priority watch checks for signals on each memory channel in sequence.

- The memory skip function and/or memory bank scan is useful to speed up the scan.

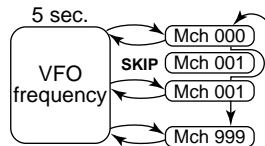

■ Priority watch operation

- ① Select *VFO mode*; then, set an operating frequency.
- ② Set the watching channel(s).
 - For memory channel watch:**
Select the desired memory channel.
 - For memory scan watch:**
Select *memory mode*, or the desired bank group; then, push and hold **[V/MHz•SCAN]** for 1 sec. to start memory scan.
- ③ Push and hold **[ATT•PRIO]** for 1 sec. to start the watch.
 - The receiver checks the memory/bank channel(s) every 5 sec.
 - The watch resumes according to the selected scan resume condition. ((p. 29))
 - While the watch is pausing, pushing and holding **[ATT•PRIO]** for 1 sec. resumes the watch manually.
- ④ Push and hold **[ATT•PRIO]** for 1 sec. to stop the watch.

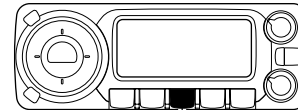

[ATT•PRIO]

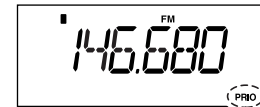

"PRIO" appears

■ Pocket beep operation

This function uses subaudible tones for calling and can be used as a “common pager” to inform you that someone has called while you were away from the receiver.

◇ Waiting for a call from a specific station

- ① Set the operating frequency in FM mode.
- ② Push **[SET•LOCK]** to enter *set mode*.

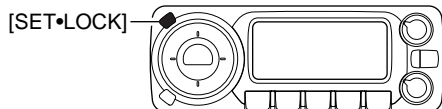

- ③ Push **[SET•LOCK]** or **[S.MW•MW]** several times until “Ct” (when selecting the tone squelch frequency) or “Dt” (when selecting the DTCS code squelch) appears.



Tone squelch frequency setting



DTCS code setting

- ④ Rotate **[DIAL]** to select the desired tone frequency or DTCS code.

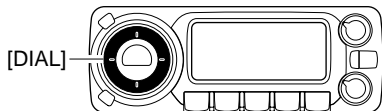

- ⑤ When operating the pocket beep function with DTCS code squelch, push **[SET•LOCK]** once then rotate **[DIAL]** to select the DTCS polarity.

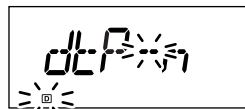

DTCS polarity setting

- ⑥ Push **[TS•MODE]** or any switch below the display to exit *set mode*.
- ⑦ Push and hold **[MONI•T/T-SCAN]** for 1 sec to enter *tone squelch selection mode*, then rotate **[DIAL]** until “((•) ▶)” or “Ⓜ((•))” appears to turn the pocket beep function ON with tone squelch or DTCS squelch, respectively.

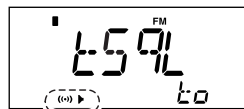
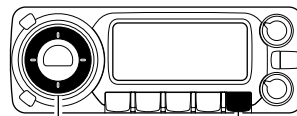

Appears when the pocket beep with tone squelch is turned ON.

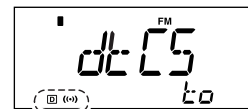

Appears when the pocket beep with DTCS squelch is turned ON.

- ⑧ Push any switch to exit *tone squelch selection mode*.



Appears when the pocket beep with tone squelch is activated.



Appears when the pocket beep with DTCS squelch is activated.

- ⑨ When a signal with the matched tone is received, the receiver emits beep tones and blinks “((•))”.
- Beep tones sound for 30 sec. and “((•))” blinks. To stop the beeps and blinking manually, push any switch.



- ⑩ Push and hold **[MONI•T/T-SCAN]** for 1 sec. to enter *tone squelch selection mode*, then rotate **[DIAL]** to cancel the tone squelch or DTCS squelch function.
- “oFF” is selected for turning the function OFF.

◇ Available tone frequency list

67.0	79.7	97.4	118.8	146.2	167.9	186.2	206.5	241.8
69.3	82.5	100.0	123.0	151.4	171.3	189.9	210.7	250.3
71.0	85.4	103.5	127.3	156.7	173.8	192.8	218.1	254.1
71.9	88.5	107.2	131.8	159.8	177.3	196.6	225.7	
74.4	91.5	110.9	136.5	162.2	179.9	199.5	229.1	
77.0	94.8	114.8	141.3	165.5	183.5	203.5	233.6	

NOTE: The receiver has 51 tone frequencies and consequently their spacing is narrow compared to units having 38 tones. Therefore, some tone frequencies may receive interference from adjacent tone frequencies.

◇ Available DTCS code list

023	054	125	165	245	274	356	445	506	627	732
025	065	131	172	246	306	364	446	516	631	734
026	071	132	174	251	311	365	452	523	632	743
031	072	134	205	252	315	371	454	526	654	754
032	073	143	212	255	325	411	455	532	662	
036	074	145	223	261	331	412	462	546	664	
043	114	152	225	263	332	413	464	565	703	
047	115	155	226	265	343	423	465	606	712	
051	116	156	243	266	346	431	466	612	723	
053	122	162	244	271	351	432	503	624	731	

◇ Calling a waiting station using pocket beep

A subaudible tone matched with the station's CTCSS tone frequency or 3-digit DTCS code with polarity is necessary. Use the tone squelch on the next page ((p. 33)).

■ Tone/DTCS squelch operation

The tone or DTCS squelch opens only when receiving a signal with the same pre-programmed subaudible tone or DTCS code, respectively. You can silently wait for the specified signal using the same tone.

- ① Set the operating frequency in FM mode.
- ② Program the CTCSS tone frequency or DTCS code in *set mode*. ((p. 31))
- ③ Push and hold **[MONI•T/T-SCAN]** for 1 sec. to enter *tone squelch selection mode*, then rotate **[DIAL]** until “▶” or “Ⓜ” appears in the function display.



Tone OFF setting



Tone squelch setting

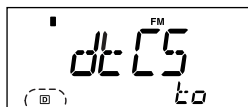

DTCS setting

- ④ When a signal with the matched tone is received, the squelch opens and the receiver emits audio.
 - When the received signal includes an unmatched tone, the squelch does not open. However, the S-meter indicator shows the received signal strength.
 - To open the squelch manually, push **[MONI•T/T-SCAN]**.
- ⑤ To cancel the tone squelch or DTCS squelch function, repeat steps ③ until “oFF” appears, then push any switch.

◇ Reverse action for tone or DTCS squelch

- Enter *tone squelch selection mode* as described in steps ① to ③ as shown left, then rotate **[DIAL]** to select either reverse action for the tone or DTCS squelch as below.

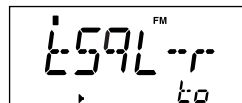

for Tone squelch

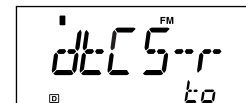

for DTCS

How does the Reverse action work?

When the reverse action is selected for either the tone squelch, “tSQL-r,” or DTCS squelch, “dtCS-r,” and a signal with the matched tone (or DTCS) is received, the squelch closes, and the receiver mutes the signal. You can listen in the signals any other than the specified one, if it’s with tone.

■ Tone scan

By monitoring a signal that is being operated with pocket beep, tone or DTCS squelch function, you can determine the tone frequency or DTCS code necessary to open a squelch.

- ① Set the desired operating frequency or memory channel to be checked for a tone frequency or code.
- ② Push and hold **[MONI•T/T-SCAN]** for 1 sec and rotate **[DIAL]** to select the tone type, tone squelch or DTCS, to be scanned.
 - Either “▶” or “◻” appears.
- ③ Push and hold **[MONI•T/T-SCAN]** for 1 sec. to start the tone scan.
 - To change the scanning direction, rotate **[DIAL]**.

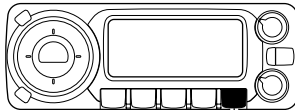

[MONI•T/T-SCAN]

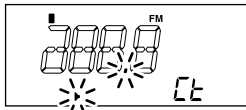

During CTCSS frequency scan

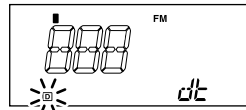

During DTCS code scan

- ④ When the CTCSS tone frequency or 3-digit DTCS code is matched, the squelch opens and the tone frequency is temporarily programmed into the selected condition such as memory channel.
 - The tone scan pauses when a CTCSS tone frequency or 3-digit DTCS code is detected.
 - The decoded CTCSS tone frequency or 3-digit DTCS code is used for the tone decoder depending on the selected tone condition or type in step ②.
 - “▶” : CTCSS tone decoder
 - “◻” : DTCS tone decoder
- ⑤ Push any switch to stop the scan.

NOTE: The decoded tone frequency is programmed temporarily when a memory is selected. However, this will be cleared when the memory channel is re-selected.

General

◆ Set mode operation

- ① Push [SET•LOCK] to enter *set mode*.
- ② Push [SET•LOCK] or [S.MW•MW] to select the desired item.
- ③ Rotate [DIAL] to select the desired condition of the item.
- ④ Push [TS•MODE] or any switch below the display to exit *set mode*.

Set mode items

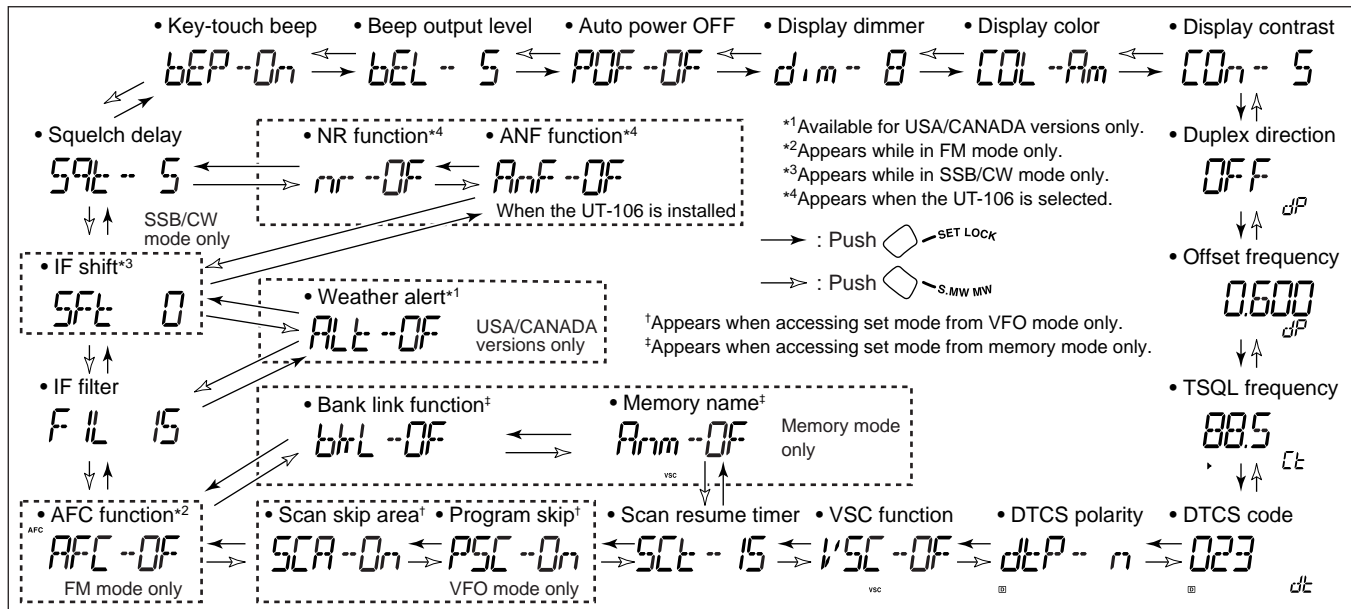

◇ Key-touch beep

The key-touch beep can be turned OFF for silent operation.
(default: ON)

bEP*On bEP*OF

Even when this item is set to OFF, the power-on beep and pocket beep function still sound. The power-on beep can not be set to OFF.

◇ Beep output level

Adjust the beep level from 1 to 9 for key-touch beep, power-on beep and pocket beep function.
(default: 5)

When the previous set mode item “bEP” is set to OFF, this setting level is not effective for key-touch beep.

bEL*1 bEL*9

◇ Auto power OFF

The receiver can be set to automatically turn OFF with a beep after a specified period when no key operations are performed.

30 min., 1 hour, 2 hours and OFF can be specified. The specified period is retained even when the receiver is turned OFF by the auto power OFF function. To cancel the function, select “OF” in this *set mode*.
(default: OFF)

POF*OF POF*30

◇ Display dimmer

Adjust the display lighting condition.
The levels 1 (dark) to 8 (bright: default) are available.

dim*8

◇ Display color

The display color can be set to amber (default), yellow or green.

COL*Ye COL*Gr

Yellow setting

Green setting

9 SET MODE

◆ Display contrast

The LCD contrast can be adjusted through 9 levels.
(default: 5)

CON: 5 CON: 1

◆ Duplex direction

Sets the duplex direction. The displaying frequency shifts the programmed offset frequency (below) when monitor function is in use (pushing [**MONI•T/T-SCAN**]).

- OFF : Simplex operation. (default)
- DUP- : The displaying frequency shifts down during monitor.
- DUP+ : The displaying frequency shifts up during monitor.

OFF_{dP} DUP+_{dP}

◆ Offset frequency

Sets the duplex offset frequency for each frequency band independently within 0 to 1000 MHz range. During duplex operation (DUP- or DUP+), the monitoring frequency (pushing [**MONI•T/T-SCAN**]) shifts the set frequency.

0.000_{dP} 0.600_{dP}

The default value may differ according to the selected frequency band (before accessing *set mode*) and receiver version.

/// The selected tuning step in *VFO mode* is used for setting the offset frequency.

◇ Tone frequency

Sets subaudible tone frequency for tone squelch operation. Total of 51 tone frequencies (67.0–254.1 Hz) are available. (default: 88.5 Hz)



• Available tone frequency list

67.0	79.7	97.4	118.8	146.2	167.9	186.2	206.5	241.8
69.3	82.5	100.0	123.0	151.4	171.3	189.9	210.7	250.3
71.0	85.4	103.5	127.3	156.7	173.8	192.8	218.1	254.1
71.9	88.5	107.2	131.8	159.8	177.3	196.6	225.7	
74.4	91.5	110.9	136.5	162.2	179.9	199.5	229.1	
77.0	94.8	114.8	141.3	165.5	183.5	203.5	233.6	

◇ DTCS code

Sets DTCS code for DTCS squelch operation. Total of 104 codes (023–754) are available. (default: 023)



• Available DTCS code list

023	054	125	165	245	274	356	445	506	627	732
025	065	131	172	246	306	364	446	516	631	734
026	071	132	174	251	311	365	452	523	632	743
031	072	134	205	252	315	371	454	526	654	754
032	073	143	212	255	325	411	455	532	662	
036	074	145	223	261	331	412	462	546	664	
043	114	152	225	263	332	413	464	565	703	
047	115	155	226	265	343	423	465	606	712	
051	116	156	243	266	346	431	466	612	723	
053	122	162	244	271	351	432	503	624	731	

◇ DTCS polarity

Sets DTCS polarities from n (normal) and r (reverse). (default: n)

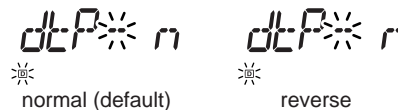

9 SET MODE

◇ VSC setting

Turns VSC (Voice Squelch Control) function ON and OFF.
(default: OFF)



◇ Scan resume timer

Selects scan resume timer from SCT-15 (default), SCT-10, SCT-5 and SCP-2. Scan resumes after the specified period when the received signal disappears.

- SCT-15/10/5 : Scan pauses for 15/10/5 sec. when the received signal disappears.
- SCP-2 : Scan pauses on a signal until signal disappears, then resumes 2 sec. after the signal disappears.



◇ Program scan skip setting

Sets the program scan skip setting ON and OFF for VFO scan operation, such as programmed scan.

(default: ON)

This item appears when set mode is accessed from VFO mode only.



◇ Scan skip area setting

Sets the pre-programmed scan skip area setting ON and OFF for VFO scan operation, such as programmed scan.

This item appears only when the scan skip area setting is programmed by the clone ((p. 44)) and set mode is accessed from VFO mode.



◇ Memory name setting

Sets memory name setting from ON (appear) and OFF (not appear; default) for memory name appearance.

This item appears when set mode is accessed from memory mode only.



◇ Memory bank link function

Sets the memory bank link function ON and OFF (default). The link function provides continuous banks scan, that scans all contents in the selected banks during bank scan.

This item appears when *set mode* is accessed from *memory mode* only.

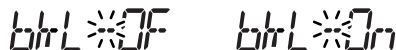

• Bank link setting

- ① Rotate **[DIAL]** to select the memory bank link function ON.
- ② Push and hold **[SET•LOCK]** or **[S.MW•MW]** for 1 sec. to enter *bank link setting mode*.
- ③ Push **[SET•LOCK]** or **[S.MW•MW]** to select the desired bank to be linked.

• A : Bank A	• b : Bank B	• C : Bank C	• d : Bank D
• E : Bank E	• F : Bank F	• G : Bank G	• H : Bank H
• J : Bank J	• k : Bank K	• L : Bank L	• m : Bank M
• n : Bank N	• o : Bank O	• P : Bank P	• q : Bank Q
• r : Bank R	• t : Bank T	• U : Bank U	• W : Bank W
• y : Bank Y			



Bank A ON



Bank A OFF

- ④ Rotate **[DIAL]** to select "On" to linking the bank.
- ⑤ Repeat steps ③ and ④ to set the link condition.
- ⑥ Push **[TS•MODE]** or any switch below the display to return to *set mode*.

◇ AFC setting

Turns AFC (Automatic Frequency Control) function ON and OFF. (default: OFF)

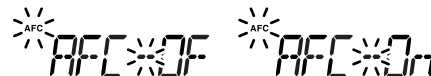

◇ Filter setting

Select the IF filter passband width from 3, 6, 15, 50 and 230 (depending on the selected mode.)



◇ Weather alert function

U.S.A./CANADA versions only

Turns weather alert function ON and OFF.



9 SET MODE

◇ IF shift frequency setting

Select the IF shift frequency up to ± 1.25 kHz (in 100 Hz steps).

This item appears when the receive mode is selected SSB or CW mode.

SFt 0 SFt +25

Center position (default) Shifts +2.5 kHz

◇ Squelch delay

Selects squelch delay from short and long to prevent repeated opening and closing of the squelch during reception of the same signal.

- S : Short squelch delay.
- L : Long squelch delay.

SqL * S SqL * L

◇ ANF setting

Turns ANF (Automatic Notch Filter) function ON and OFF. The ANF function automatically attenuates up to 3 beat tones, tuning signals, etc. even if they are moving. The ANF function can be used in SSB, AM, FM and WFM modes.

☞ This item appears when optional UT-106 is installed.

Anf * Off Anf * On

◇ NR setting

Selects NR (Noise Reduction) level from 1 to 15 and OFF (Default).

The NR function enhances desired signals in the presence of noise by using the DSP circuit. The amount of enhancement is adjustable.

The NR level can result in audio signal masking. Set the noise reduction level for maximum readability.

☞ This item appears when optional UT-106 is installed.

nr * 1 nr * 15

■ Weather channel operation (USA/CANADA versions only)

◇ Weather channel selection

- ① Push **[MR•SKIP]** twice and rotate **[DIAL]** to select weather channel group, then push **[MR•SKIP]** again.

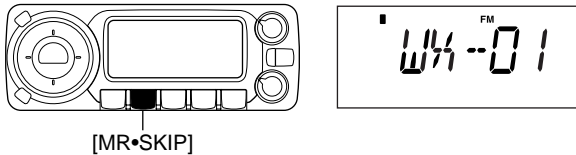

- ② Rotate **[DIAL]** to select the desired weather channel.
- ③ To cancel the weather channel, repeat step ① and select the memory channel group, "bAnk --" or push **[V/MHz•SCAN]** to select VFO mode.

◇ Weather alert function

NOAA broadcast stations transmit weather alert tones before important weather announcements. When the weather alert function is turned ON, the selected weather channel is monitored each 5 sec. for the announcement. When the alert signal is detected, the "AL.T" and the WX channel are displayed alternately and sounds a beep tone until the receiver is operated. The previously selected (used) weather channel is checked periodically during standby or while scanning.

- ① Select the desired weather channel.
- ② Turn the weather alert function ON in set mode.
 - ➔ Push **[SET•LOCK]** to enter set mode.
 - ➔ Push **[SET•LOCK]** or **[S.MW•MW]** to select the weather alert item, then rotate **[DIAL]** to set ON.
 - ➔ Push any switch below the display to exit set mode.
- ③ Sets the desired stand-by condition.
 - Selects VFO or memory channel.
 - Scan or priority watch operation can also be selected.
- ④ When the alert is detected, a beep sounds and the following indication will be displayed.

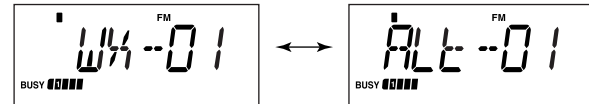

Shows above indications alternately.

- ⑤ Turn the weather alert function OFF in set mode.

NOTE: While receiving a signal (on a frequency other than the weather alert ON frequency), the receiving signal or audio will be interrupted momentarily every 5 sec. (approx.) in case the alert function is turned ON. This symptom is caused by the WX alert function. To cancel these symptoms, set the weather alert item OFF in set mode.

10 OTHER FUNCTIONS

■ DSP operation (Optional UT-106 is required)

◆ ANF function

USING SET MODE

The ANF (Automatic Notch Filter) function automatically attenuates beat tones, tuning signals, etc., even if they are moving. This function can be activated in SSB, AM, FM modes.

- ① Select any of SSB, AM or FM mode.
- ② Push **[SET•LOCK]** to enter *set mode*.
- ③ Push **[SET•LOCK]** or **[S.MW•MW]** several times until “AnF” appears.

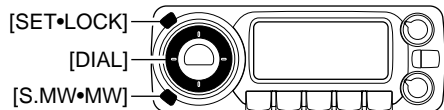

- ④ Rotate **[DIAL]** to toggle the ANF function ON and OFF.



- ⑤ Push **[TS•MODE]** to exit *set mode*.
 - “DSP” appears when the DSP function (either ANF or NR functions) is in use.



◆ NR function

USING SET MODE

The NR (Noise Reduction) function reduces noise components and picks out desired signals which are buried in noise. The received AF signals are converted to digital signals and then the desired signals are separated from the noise. This function is available for all operating modes.

- ① Push **[SET•LOCK]** to enter *set mode*.
- ② Push **[SET•LOCK]** or **[S.MW•MW]** several times until “nr” appears.

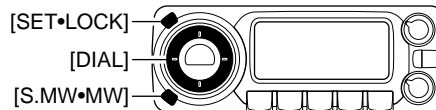

- ③ Rotate **[DIAL]** to select the NR level from 1 to 15 or OFF.



- ④ Push **[TS•MODE]** to exit *set mode*.
 - “DSP” appears when the DSP function (either ANF or NR functions) is in use.



■ DATA cloning (IC-PCR1500 control software must be installed)

Cloning allows you to quickly and easily transfer the programmed contents from a personal computer to a receiver using the IC-PCR1500 control software.

◇ Cloning using a personal computer

Data can be cloned to and from a personal computer (Microsoft® Windows® XP/2000/Me/98SE) and the other setting can also be programmed from a PC. Consult the cloning instruction manual for details.

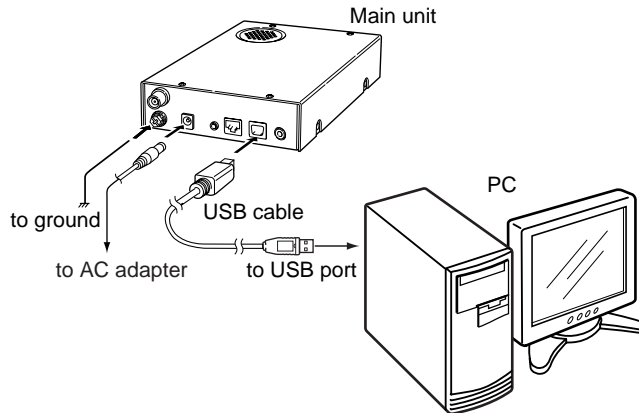

◇ Available functions

- Reading or writing Clone Data
- Programming memory channels/memory banks/scan edges
- Programming set mode settings
- Converting the Data both of PC (PCR1500) to receiver (R1500) or receiver (R1500) to PC (PCR1500)
- Automatic mode settings
 - The automatic mode setting is available to automatically set the receive mode, IF filter passband width, tuning step, etc. after inputting frequency ranges.
- Skip area settings
 - The skip area setting is available for skipping unwanted frequency ranges that inconveniently stop scanning.

Microsoft and Windows are registered trademarks of Microsoft Corporation in the U.S.A. and other countries.

10 OTHER FUNCTIONS

■ Partial reset

AT POWER ON

If you want to initialize the operating conditions (VFO frequency, VFO settings, set mode contents) without clearing the memory contents.

- ➔ While pushing [V/MHz•SCAN] and [SET•LOCK], push and hold [PWR] for 1 sec. to reset CPU partially.

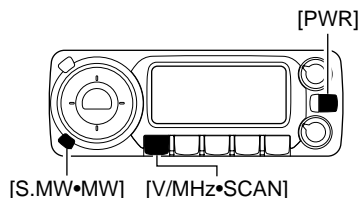

■ All reset

AT POWER ON

The function display may occasionally display erroneous information (e.g. when first applying power). This may be caused externally by static electricity or by other factors.

If this problem occurs, turn power OFF. After waiting a few seconds, turn power ON again. If the problem persists, perform the following procedure.

- Partial resetting is also available. See left for details.

/// IMPORTANT!:

Resetting the receiver **CLEARs** all memory information and initializes all values in the receiver.

- ➔ While pushing [S.MW•MW] and [SET•LOCK], push and hold [PWR] for 1 sec. to reset the CPU.

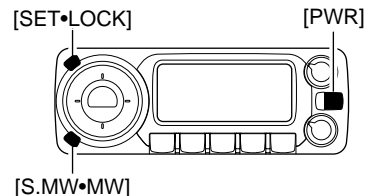

■ Internal audio switch

The internal switch must be toggled when using an external speaker, headphones or earphone.

/// Before removing the top cover, turn the receiver power OFF, then disconnect the DC power cable.

- ① Turn the power OFF, then disconnect the DC power cable.
- ② Unscrew the 8 screws and disconnect the connected cables, then remove the top cover.
 - Be careful not to lost the screws.

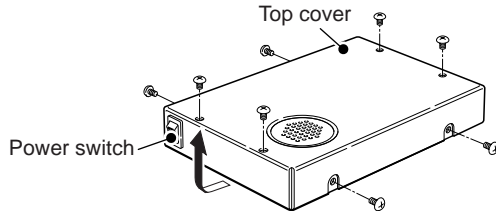

- ③ Toggle the switch as usage (shown at right).
 - Toggles the switch to [SPEAKER] when an external speaker is connected to the receiver. (default)
 - Toggles the switch to [PHONES] when headphones or an earphone are/is connected to the receiver.
- ④ Return the top cover, cables and screws to the original position.

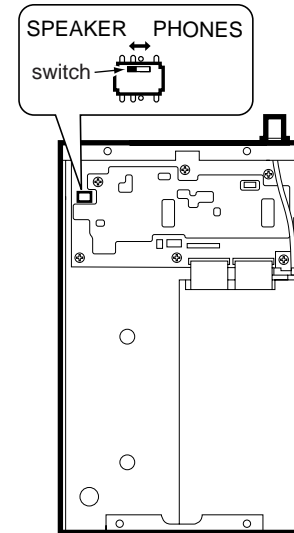

11 TROUBLESHOOTING

If your receiver seems to be malfunctioning, please check the following points before sending it to a service center.

PROBLEM	POSSIBLE CAUSE	SOLUTION	REF.
Does not turn on.	<ul style="list-style-type: none"> • An AC adapter is not connected to the receiver. 	<ul style="list-style-type: none"> • Check the connection. 	p. 1
No sound comes from the speaker.	<ul style="list-style-type: none"> • Volume level is too low. • Squelch level is set too high. • Different tone is selected with tone or DTCS squelch. 	<ul style="list-style-type: none"> • Rotate [VOL] to obtain a suitable level. • Rotate [SQL] to set the squelch level. • Turn the appropriate function OFF. 	p. 11 p. 11 p. 33
Sensitivity is low and only strong signals are audible.	<ul style="list-style-type: none"> • Antenna feedline or the antenna connector has a poor contact or is short circuited. • Attenuator function is activated. 	<ul style="list-style-type: none"> • Check, and if necessary, replace the feedline or solder the antenna connector again. • Push [ATT•PRIO] to turn the Attenuator function OFF. 	p. 1 p. 12
Frequency cannot be set.	<ul style="list-style-type: none"> • The lock function is activated. 	<ul style="list-style-type: none"> • Push and hold [SET•LOCK] for 1 sec. to turn the function OFF. 	p. 11
Program scan does not operate.	<ul style="list-style-type: none"> • The squelch is open. • The start and end frequencies are the same. 	<ul style="list-style-type: none"> • Set the squelch to the threshold point. • Set the different frequencies. 	p. 11 p. 27
Memory scan does not operate.	<ul style="list-style-type: none"> • The squelch is open. • Only 1 memory channel is programmed or other channels are set as skip channel. 	<ul style="list-style-type: none"> • Set the squelch to the threshold point. • Program other memory channels or cancel the memory skip function in the desired channels. 	p. 11 pgs. 17, 28
Receive audio is distorted.	<ul style="list-style-type: none"> • The operating mode is not selected correctly. 	<ul style="list-style-type: none"> • Push and hold [TS•MODE] for 1 sec., then rotate [DIAL] to select suitable operating mode. 	p. 10



We Icom Inc. Japan
 1-1-32, Kamiminami, Hirano-ku
 Osaka 547-0003, Japan

Declare on our sole responsibility that this equipment complies with the essential requirements of the Radio and Telecommunications Terminal Equipment Directive, 1999/5/EC, and that any applicable Essential Test Suite measurements have been performed.

Kind of equipment: COMMUNICATIONS RECEIVER

Type-designation: IC-PCR1500/R1500

Version (where applicable):

This compliance is based on conformity with the following harmonised standards, specifications or documents:

- i) Article 3.1a EN 60950-1 (2001):A11:2004
- ii) Article 3.1b EN 301489-1 and EN 301489-15
- iii) Article 3.2 EN 301 783-2
- iv) _____
- v) _____

DECLARATION OF CONFORMITY



Düsseldorf 5th Dec.2005
 Place and date of issue

Icom (Europe) GmbH
 Himmelgeister straÙe 100
 D-40225 Düsseldorf

Authorized representative name
 H. Ikegami
 General Manager

Signature

Icom Inc.

11
 12

Count on us!

#02 Europe

<Intended Country of Use>			
<input checked="" type="checkbox"/> GER	<input type="checkbox"/> FRA	<input checked="" type="checkbox"/> ESP	<input checked="" type="checkbox"/> SWE
<input checked="" type="checkbox"/> AUT	<input checked="" type="checkbox"/> NED	<input checked="" type="checkbox"/> POR	<input checked="" type="checkbox"/> DEN
<input type="checkbox"/> GBR	<input checked="" type="checkbox"/> BEL	<input checked="" type="checkbox"/> ITA	<input checked="" type="checkbox"/> FIN
<input checked="" type="checkbox"/> IRL	<input checked="" type="checkbox"/> LUX	<input checked="" type="checkbox"/> GRE	<input checked="" type="checkbox"/> SUI
<input checked="" type="checkbox"/> NOR			

#03 U.K.

<Intended Country of Use>			
<input type="checkbox"/> GER	<input type="checkbox"/> FRA	<input type="checkbox"/> ESP	<input type="checkbox"/> SWE
<input type="checkbox"/> AUT	<input type="checkbox"/> NED	<input type="checkbox"/> POR	<input type="checkbox"/> DEN
<input checked="" type="checkbox"/> GBR	<input type="checkbox"/> BEL	<input type="checkbox"/> ITA	<input type="checkbox"/> FIN
<input type="checkbox"/> IRL	<input type="checkbox"/> LUX	<input type="checkbox"/> GRE	<input type="checkbox"/> SUI
<input type="checkbox"/> NOR			

#06 France

<Intended Country of Use>			
<input type="checkbox"/> GER	<input checked="" type="checkbox"/> FRA	<input type="checkbox"/> ESP	<input type="checkbox"/> SWE
<input type="checkbox"/> AUT	<input type="checkbox"/> NED	<input type="checkbox"/> POR	<input type="checkbox"/> DEN
<input type="checkbox"/> GBR	<input type="checkbox"/> BEL	<input type="checkbox"/> ITA	<input type="checkbox"/> FIN
<input type="checkbox"/> IRL	<input type="checkbox"/> LUX	<input type="checkbox"/> GRE	<input type="checkbox"/> SUI
<input type="checkbox"/> NOR			